

Geist

SPECIFICATION SHEET

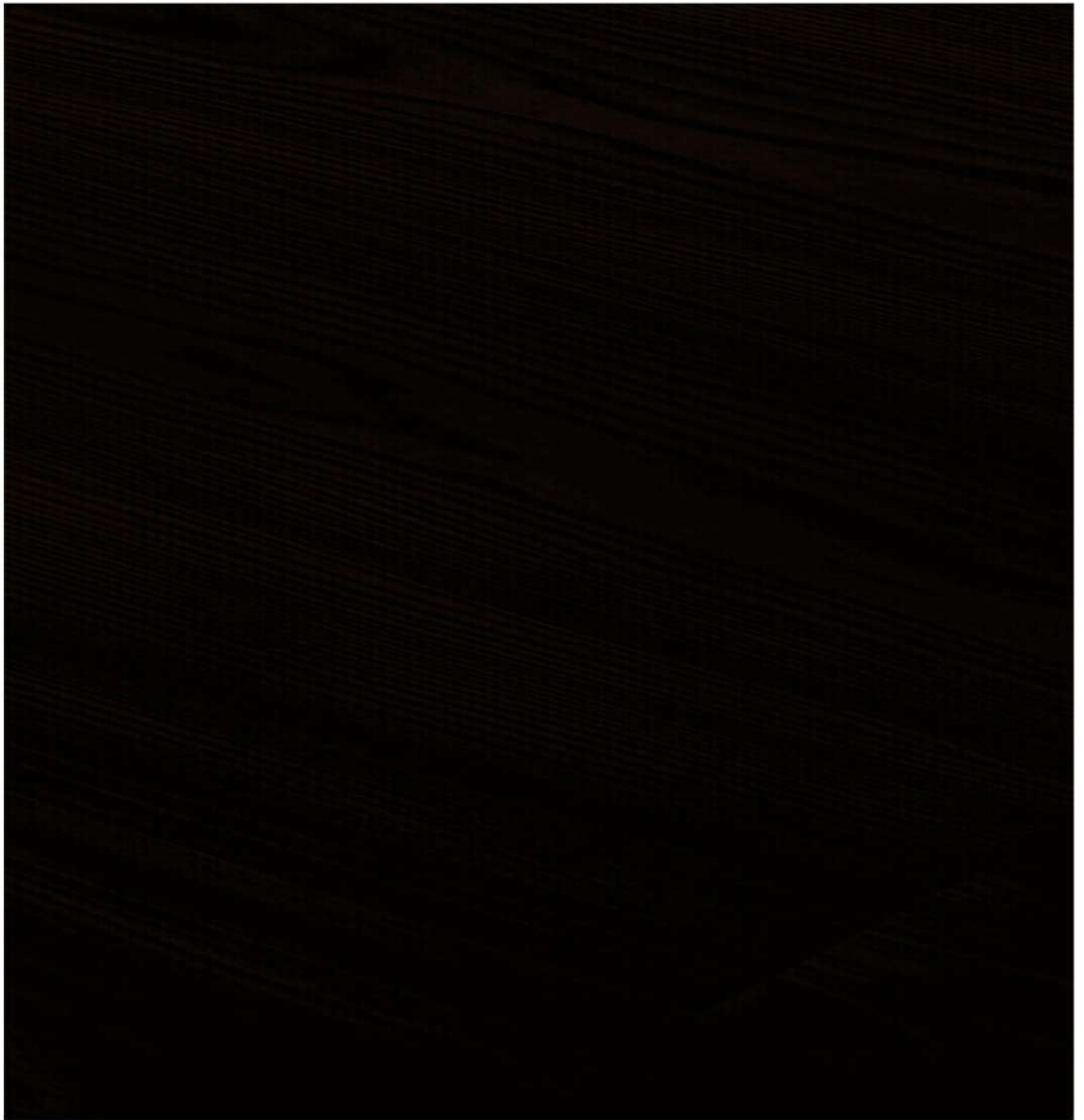

Not for everyone

THE PRODUCT

On the way to developing the next generation of healthy living and particularly water-resistant design floor, we have combined trend-setting materials, authentic surfaces, and smart technology. Geist wooden flooring in two types of solid wood and engineering, is made of Elm wood and is finished in the factory with a hi-tech color and natural oil. The distorted and linear veins of Elm wood give an attractive and charming appearance to this wooden flooring. When you buy a wood floor from us, you choose quality, innovation and respect for the nature!

Geist



MORFLOOR













TECHNICAL DATA



Nile board is 15 mm thick and has bevels on all four sides. The boards are connected using tongue and groove method.

Type of flooring: Engineered	Thickness: 15 mm	Finish: Natural oil
Product series: 35902	Length: 1000 - 2000 mm	Surface finish: Sanding grade 180
Wood species: Elm	Width: 80 - 180 mm	Edge: Micro Edge 0.5 mm
Style: Modern	Density: 600- 700 kg / m ³	Grading: RP
Color: Black	Area of each carton: ~ 1.2 m ²	Installation: Floating- Glue-down
Texture: Wired	Underfloor heating: Suitable	Connection: T/G

General Material Performance Data

											
COMPATIBLE WITH UNDERFLOOR HEATING	EASY STAIN REMOVAL	SUITABLE FOR OFFICE CHAIRS	APPROVED FOR EMISSIONS	HIGH PRESSURE EXTREME DURABLE	SILENT SYSTEM	HIGH COMPRESSIVE STRENGTH	WITHSTANDS SPECIFIED CHEMICALS	EASY MAINTENANCE	DOES NOT FADE IN DIRECT SUNLIGHT	SCRATCH RESISTANT	PERFECT FINISH



BEVELS



Geist is manufactured with 0.5 mm bevels on both the long and short edges for natural looks.

Core layer: Birch plywood
Overall thickness: 15 mm

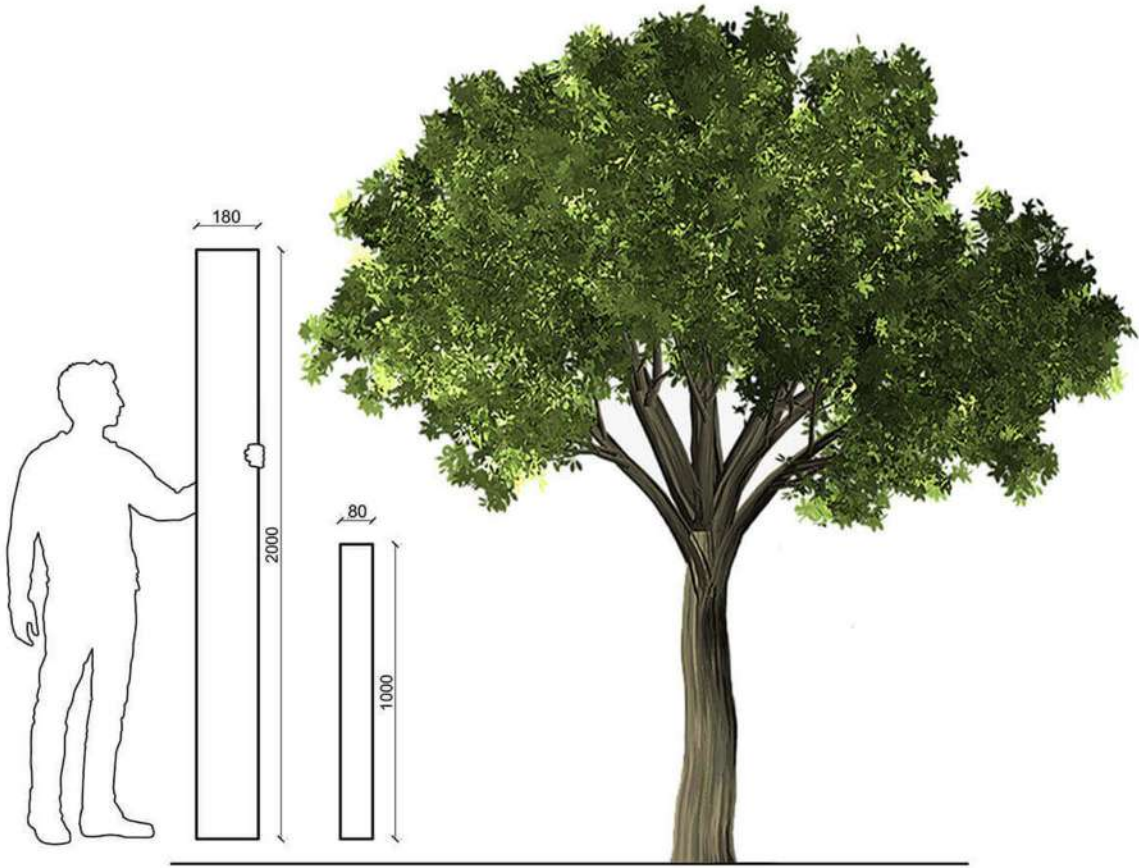
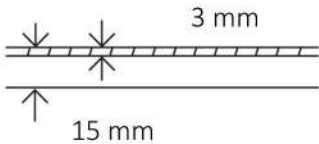

Engineered Natural grade Elm

PROCESS AND PROCEDURE

COLOR AND FINISH

Our finishing process and materials allow us to develop a wide range of colors and effects – from the subtlest of tints to the most colorful of flairs



SIMPLIFIED INSTALLATION

It's just like a kids' puzzle with a cheat sheet. The boards are numbered and mapped to allow for installation no more difficult than the standard straight floor



CARE AND MAINTENANCE

Depending on the materials and finish used, every floor gets a unique maintenance plan the customer can follow to ensure the beauty lasts for many generations



INSTALLATION at a GLANCE

PREPARED SUBSTRATE

Lay out the underlay on the prepared substrate.



CENTRE/ANGLE

Centre/angle the installation area and adjust the first row of planks by cutting it to size.



SPACERS

Use the MDF or plastic spacers to maintain a clearance of at least 10mm to 15mm from all walls and fixed objects in the room.



INSTALLATION at a GLANCE

CUT THE LAST PLANK

Cut the last plank of the first row to the necessary length, considering the wall clearance. The cut piece of the plank is used to start the second row.



START THE NEXT ROW

Start the next row from the left. Simply click the long sides of the planks together. The planks must not be glued.



HEAD JOINTS

Join head joints using a hammer and protective block. The long and head joints will connect automatically. Continue this installation throughout the whole room.



INSTALLATION at a GLANCE

TRANSFER THE WALL OUTLINE

Use a remnant or the Morfloor MultiTool to transfer the wall outline to the last row of planks.



COVER EDGE CLEARANCES

Cover edge clearances using matching skirting boards from the extensive Morfloor product range.





TOP LAYER

High-quality soft wood with a thickness of up to 3 mm is finished with a lacquered or naturally oiled surface. The lamella impregnation on the head side as well as the all-round impregnated top layer prevent moisture from penetrating and ensure enhanced swell-protection. The gentle drying process prevents cracking.

PLYWOOD MIDDLE LAYER

The excellent dimensional stability of Morfloor engineered wood flooring even under maximum load comes from the solid wood core with its vertical annual rings. The T&G click mechanism milled into the wood ensures a long-term stable connection.

TONGUE AND GROOVE CONNECTION

Tried and tested installation type with a classic connection for maximum installation options.

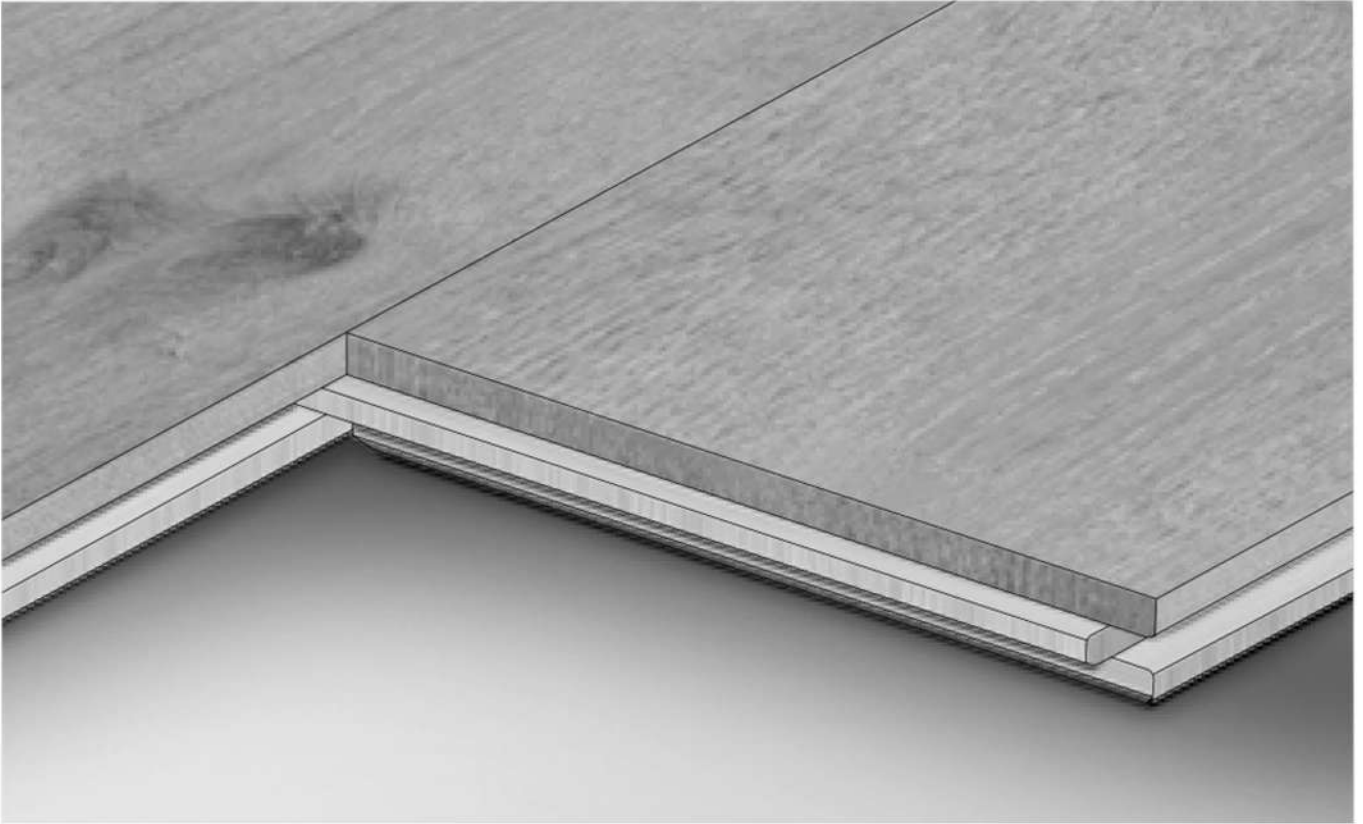

CLASSIC TONGUE AND GROOVE CONNECTION

The all-round tongue and groove profile is characterized by maximum fitting accuracy and ease of installation. The use of a loose tongue in open Frameworks offers countless installation options. The groove is a deep ridge cut along the entire edge (usually in the shape of an open-ended teardrop). The tongue is on the opposite edge and is of the appropriate shape to fit like a puzzle piece into the groove. The tongue is made to be slightly smaller than the area of the groove, to aid in smoother assembly. They are put together by sliding them down the edge to edge, starting at the tips of each panel. Then the glue is added to the joint, and the tongue slightly absorbs some of the moisture and expands into the groove to make for a wonderfully snug fit.

INSTALLATION RULES

INSPECTING FOR MATERIAL DAMAGES

Engineered wood flooring planks should be checked thoroughly for material defects before and during installation (e.g. improper transportation). Planks with visible defects or damage must not be installed. Assembly should only take place in daylight or with adequate lighting, as any damaged or faulty boards may not be detected.

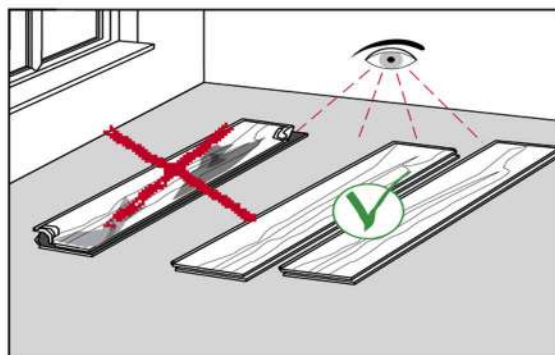

ACCLIMATISATION BEFORE INSTALLATION

Engineered wood flooring planks must be acclimatised over a period of at least 48 hours at a room temperature of at least 17°C and a relative humidity of 30–65% in the room where they are being installed. That means that the sealed packages must adjust to the climate conditions in the room. If there are major climate differences between the storage area and the room of installation, the acclimatisation period should preferably be longer.

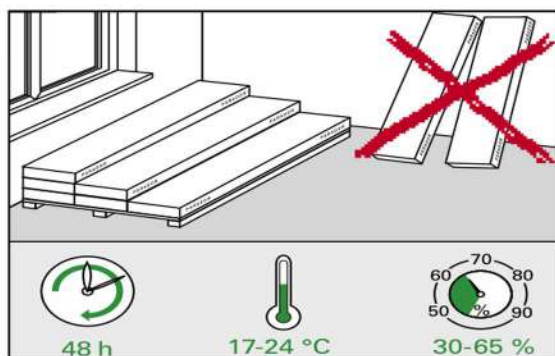

INSTALLATION IN DAMP ROOMS

Engineered wood flooring must not be installed in areas where water is likely to lodge on the floor. Standing water penetrates the wood and causes permanent damage. In permanently damp areas or damp environments (sauna areas, small bathrooms etc.), engineered wood flooring should not be installed, as the risk of moisture penetrating cannot be ruled out.

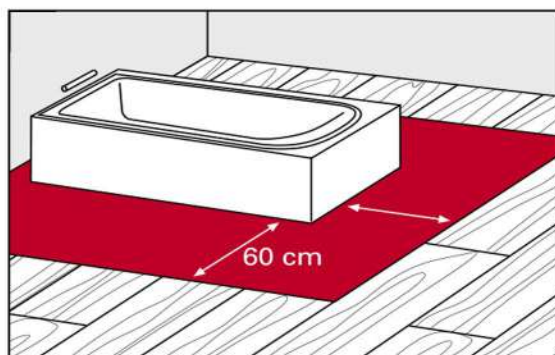

INSTALLATION RULES

SUBFLOOR CONDITION

All existing subfloors must be level (max. 3 mm over 1 m length), dry, and sufficiently solid. In case of bigger uneven patches, these must be filled with commercially available filler. The subfloor surface should be without cracks, breaks, or gaps. Loose subfloors (PVC / carpet) must be removed. Mineral subfloors / screed must be sufficiently dry.

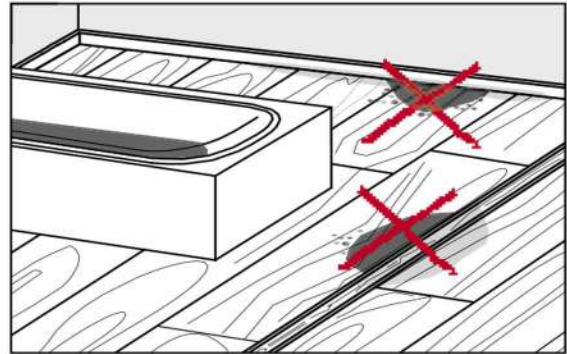

VAPOUR BARRIER FOR MINERAL SUBFLOORS

With dry, mineral subfloors, as a precautionary measure a 0.2 mm thick PE film or alternatively a Morfloor underlay with integrated moisture protection must be placed underneath. However, the foam is only a vapour barrier and should be overlapped by approximately 30 cm and glued. Under no circumstances should a foam be used to waterproof a building!

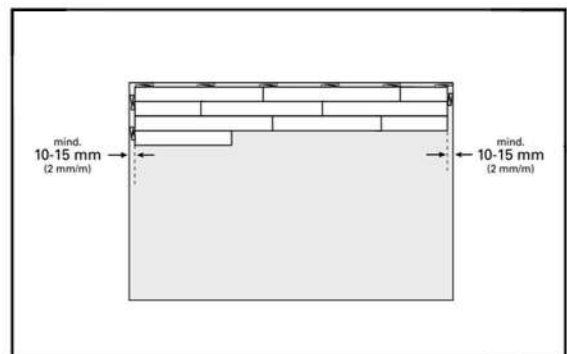

MAINTAIN EXPANSION JOINTS

As already described above, the natural material wood swells or shrinks depending on climatic conditions. Therefore, installed engineered wood flooring requires a corresponding clearance to all fixed components, i.e. walls, supports, heater pipes, etc. This is called the wall clearance or expansion joint.

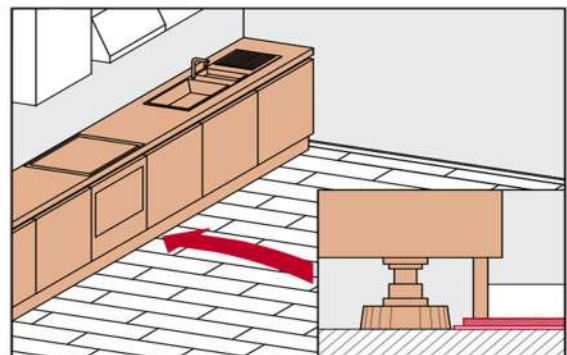

INSTALLATION RULES

LAYOUT OF EXPANSION JOINTS

As engineered wood flooring will swell or shrink depending on climate conditions, further expansion and movement joints of at least 10 mm are necessary under the following circumstances:

- > larger areas (over 8 × 12 m)
- > irregular shaped areas
- > installation from room to room

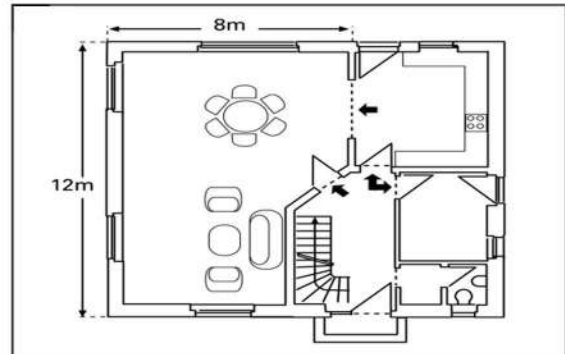

PATTERN AND OFFSET INSTALLATION

Engineered wood flooring planks can be installed in a symmetric or asymmetric pattern. In both cases the overlap or minimum offset of the head joints must be > 40 cm.

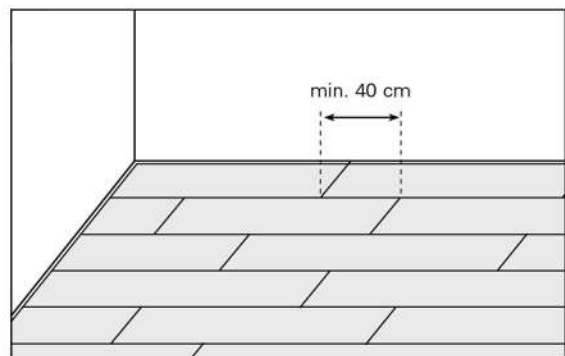

INCIDENCE OF LIGHT

For optical reasons, the planks should be laid parallel from the incidence of light, i.e. the long side runs in the same direction as the light entering the room. If there is more than one window, please go by the largest window. If the floor plan of the room is very unusual, the direction of installation should also be judged according to how the room is divided.

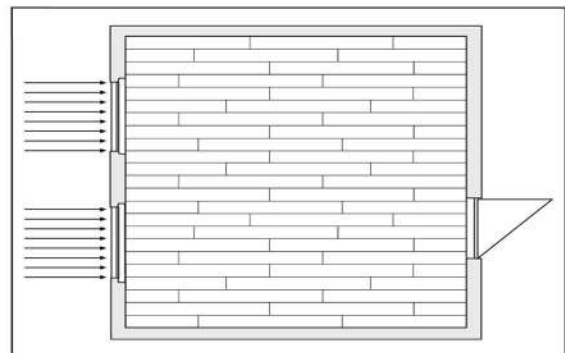

INSTALLATION RULES

INSTALLATION DIRECTION / ROOM FLOOR PLAN

Also for optical reasons, the long sides of the floor should be at right angles to the long side of the room. This makes the room appear squarer and bigger instead of long and “tube-like.”

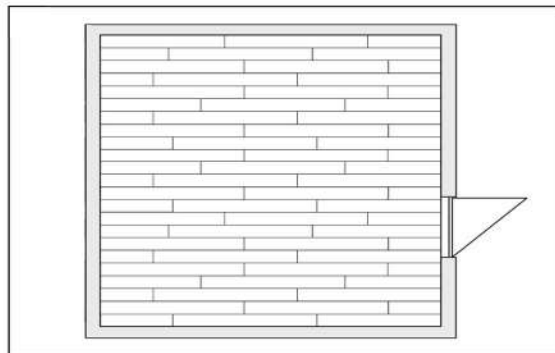

INSTALLATION FROM MULTIPLE PACKAGES

Engineered wood flooring is a natural product that enhances its unique character with color and texture. These natural features are always different. Therefore, it is always necessary that planks from different packages are mixed during installation in order to maintain a balanced appearance.

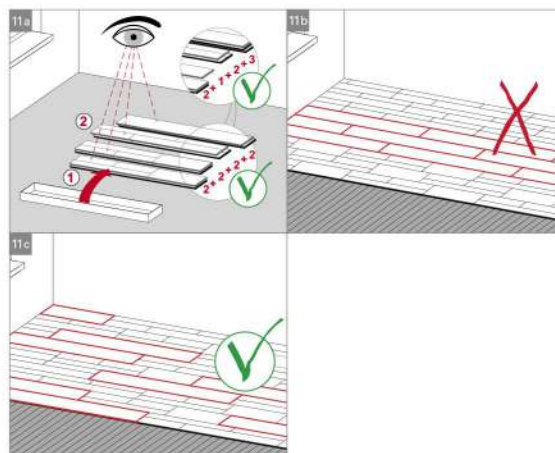

CARE AND MAINTENANCE

Morfloor wooden flooring last for generations. The protective microporous finish allows the wood to breathe, thus keeping it „healthy“. The finish repels moisture and dirt. And should any dirt or damage occur, it is easy to clean and repair. Floor care for oiled floors is easy if you follow some basic rules.



For more information, ask for *Installation, maintenance and cleaning guide.*

DUSTING

An oiled wooden floor repels dirt. Unlike many other types of flooring, it does not develop an electrostatic charge and does not offer breeding grounds for microbes and allergens. Dust, lint or animal hair can be removed with a vacuum cleaner or broom.



VACUMING

As painful as this one also sounds, weekly vacuuming is not only key to keeping your home clean, but also making sure any crumbs and dirt you missed while sweeping don't scratch your floor.



CARE AND MAINTENANCE

MOPPING

How often your wood flooring has to be mopped depends on the demands placed on it. For private households, once a week is normally enough, for restaurants and other high traffic areas, you should mop floors daily.



SCRATCHING

- Place felt pads or soft furniture protectors under all furniture. Narrow glides and casters can damage wooden floors, so switch to wide types if possible. PICK UP all furniture to move over flooring.
- Do not wear high heels, cleats, cowboy boots or work boots on wood floors as the concentrated heel pressure can leave indents. We suggest removing shoes when entering your house to minimize tracking in dirt on soles.
- Keep pet nails trimmed and minimize animal play on wood floors to prevent scratching and dulling of wood finish.
- Elevate potted plants from flooring as moisture can seep from ceramic pots and leave marks on wood floors.





NOT FOR EVERYONE

Not for everyone. Morfloor designs your floor. For any space where all the elements are special and details are present everywhere. Morfloor parquets are not just for floor coverings. Here we are dealing with a kind of art that, inspired by nature and geometry, gives character to the floor of the house. Morfloor avoids conventional production norms. It doesn't have to be rectangular; it doesn't have to be similar, and it's not even necessary to use wood with an orientation similar to all the products on the market. In that sense, Morfloor wooden flooring is luxurious and is not for everyone. Being unique, along with being professional and, most importantly, loving nature is our way. Breaking the conventional production cycle is our mission. And of course, with every product we build, every project we participate in, and every expert we hire, we are one step closer to our goal.



For further assistance

Call: +98(021)77801530

Email: info@morfloor.ir

Web: www.morfloor.ir

Morfloor Wooden Flooring

Unit 1, No. 46, 216 West St. , Tehranpars Ave. , Tehran, Iran